



BRIGHTTEK
BRIGHTTEK (EUROPE) LIMITED

Brighten Up The World With LED!



ISO/TS 16949:2009



BS EN ISO 14001:2004



QC 080000 IECQ HSPM

PRODUCT DATASHEET



- ▶ PTH Lamp
- ▶ 3mm Round 5.3t
- ▶ Sky White (Ice Blue)

NOW33L36 (Bulk)
 NOW33L36T (Taping)



Release Date: 27 December 2023 Version: A1.1



3 m m R o u n d L a m p

3mm Round Lamp

RoHS
 Compliant



FEATURES:

- **Package:** PTH/THT Lamp 3mm Round 5.3t
- **Forward Current:** 20mA
- **Forward Voltage (typ.):** 3.2V
- **Luminous Intensity (typ.):** 10000mcd@20mA
- **Colour:** Sky White (Ice Blue)
- **Colour Temperature:** 24000K (X=0.2600; Y=0.2400)
- **Viewing Angle:** 36°
- **Electrostatics Discharge (ESD):** 200V
- **Materials:**
 - Die: InGaN
 - Resin: Epoxy (Water Clear)
- **Operating Temperature:** -40~+85°C
- **Storage Temperature:** -40~+100°C
- **Grouping Parameters:**
 - Forward voltage
 - Luminous intensity
 - CIE Chromaticity
- **Soldering Methods:** Hand; Soldering Heat (DIP)
- **Packing:** 500pcs/bulk; 2000pcs/tape (ammo pack)

APPLICATIONS:

- Indicator
- Switch
- Signal Light

CHARACTERISTICS:

Absolute Maximum Characteristics (Ta=25°C)

Parameter	Symbol	Ratings	Unit
Forward Current	I _F	30	mA
Peak Forward Current Duty 1/10@1KHz	I _{FP}	100	mA
Reverse Current @5V	I _R	10	μA
Power Dissipation	P _D	85	mW
Electrostatics Discharge	ESD	200	V
Operating Temperature	T _{OPR}	-40~+85	°C
Storage Temperature	T _{STG}	-40~+100	°C

Electrical & Optical Characteristics (Ta=25°C)

Parameter	Symbol	Values			Unit	Test Condition
		Min.	Typ.	Max.		
Forward Voltage	V _F	2.8	3.2	3.4	V	I _F =20mA
Luminous Intensity	I _v	8000	10000	16500	mcd	I _F =20mA
Chromaticity Coordinates	X	---	0.2600	---	---	I _F =20mA
	Y	---	0.2400	---		
Colour Temperature	CCT	---	24000	---	K	I _F =20mA
Viewing Angle	2θ _{1/2}	---	36	---	deg	I _F =20mA

- Luminous intensity (I_v) ±15%, Forward Voltage (V_F) ±0.1V

OUTLINE DIMENSION:

Package Dimension:

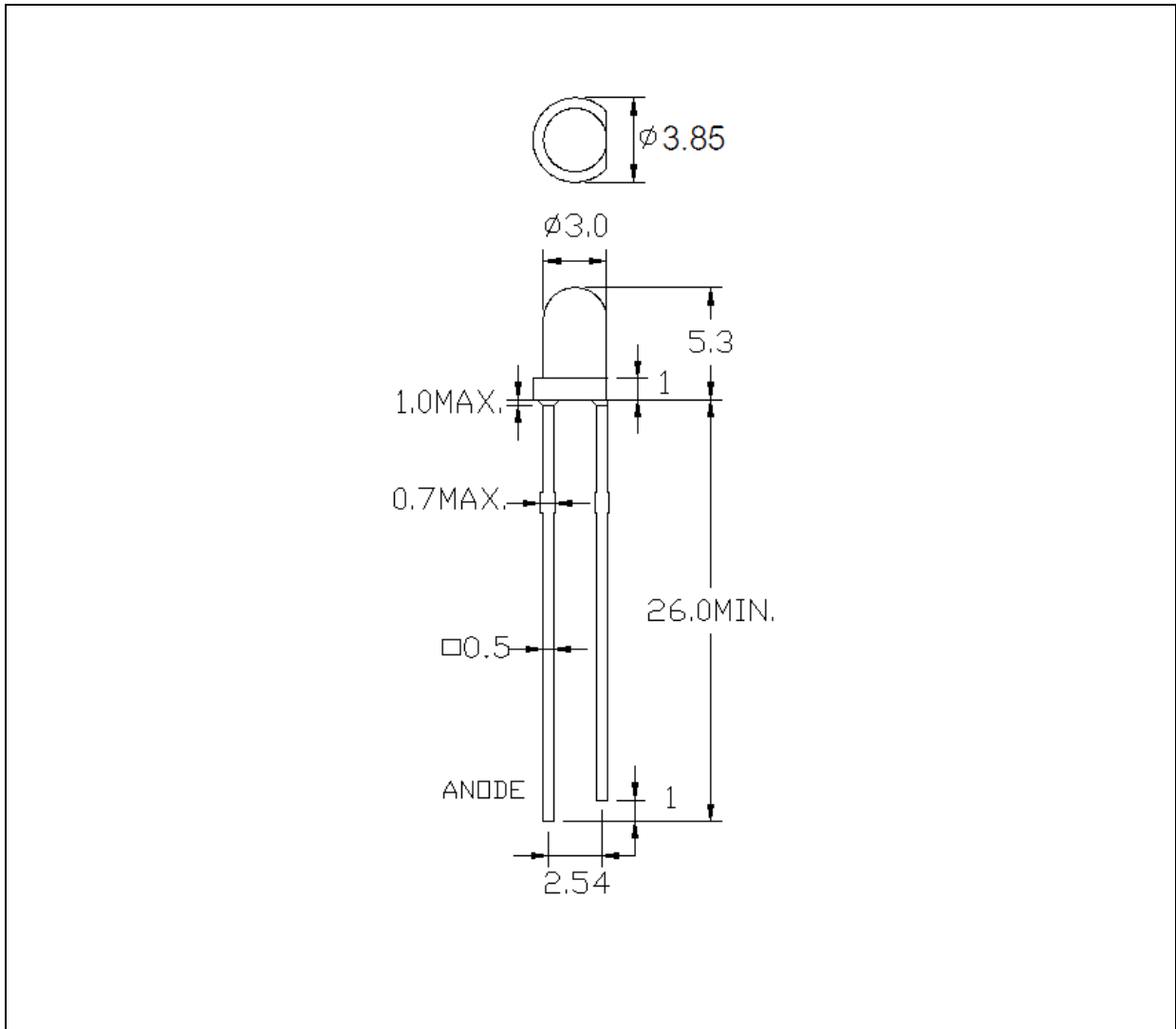

1. All dimensions are in millimetre (mm).
2. Tolerance $\pm 0.25\text{mm}$, unless otherwise noted.

BINNING GROUPS:

 Forward Voltage Classifications ($I_F = 20\text{mA}$):

Code	Min.	Max.	Unit
J	2.8	3.0	V
K	3.0	3.2	
L	3.2	3.4	

 Luminous Intensity Classifications ($I_F = 20\text{mA}$):

Code	Min.	Max.	Unit
21	7300	11000	mcd
22	11000	16500	

CIE CHROMATICITY DIAGRAM:

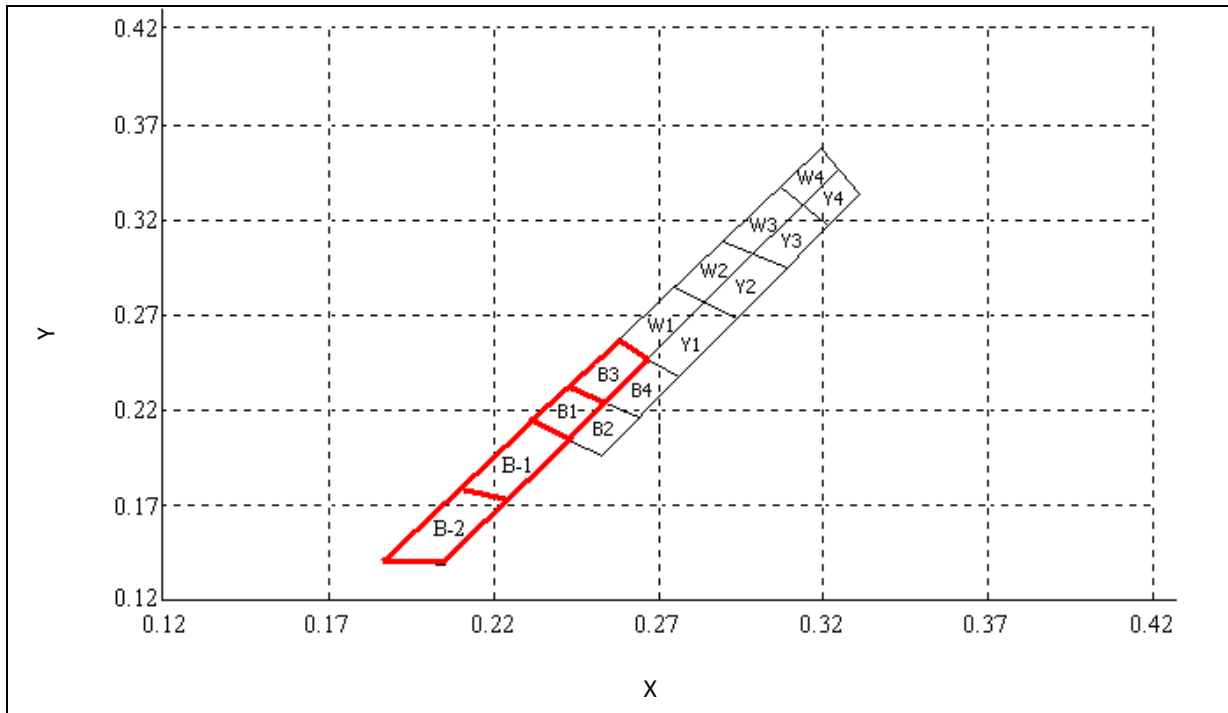

Chromaticity Coordinates Classifications ($I_F = 20\text{mA}$):

	1		2		3		4	
	X	Y	X	Y	X	Y	X	Y
B-1	0.2100	0.1800	0.2300	0.2100	0.2400	0.2050	0.2250	0.1750
B-2	0.1900	0.1500	0.2100	0.1800	0.2250	0.1750	0.2050	0.1450
B1	0.2300	0.2100	0.2450	0.2350	0.2540	0.2290	0.2400	0.2050
B3	0.2450	0.2350	0.2600	0.2600	0.2680	0.2530	0.2540	0.2290

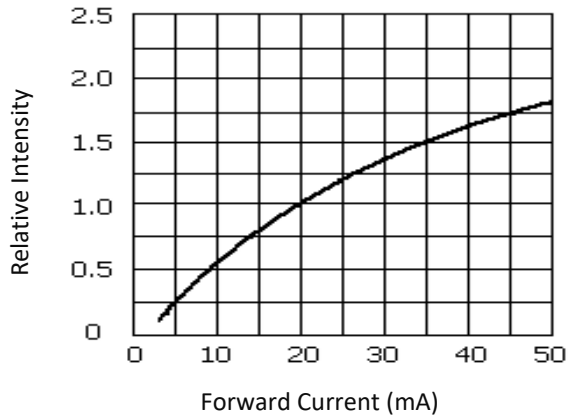
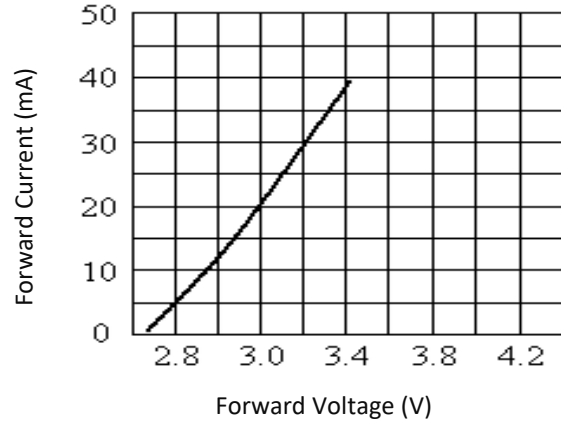
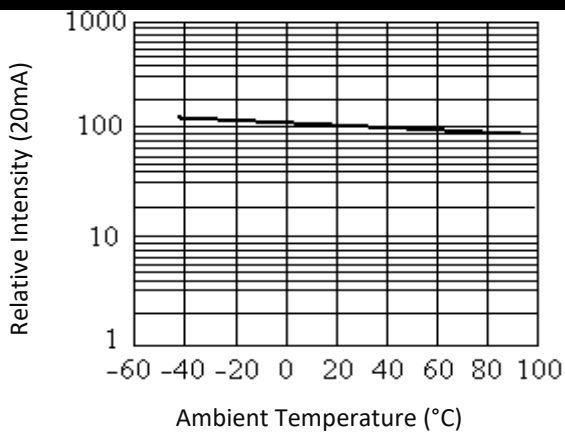
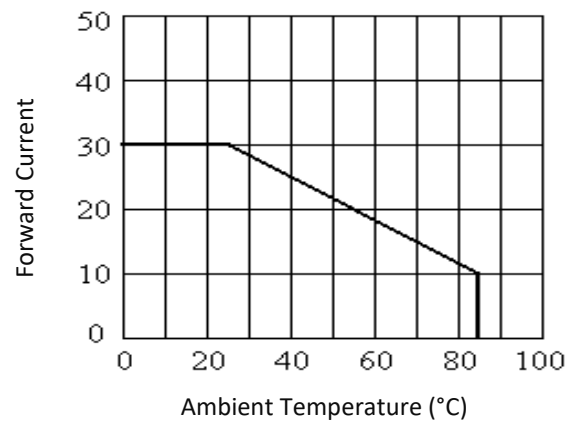
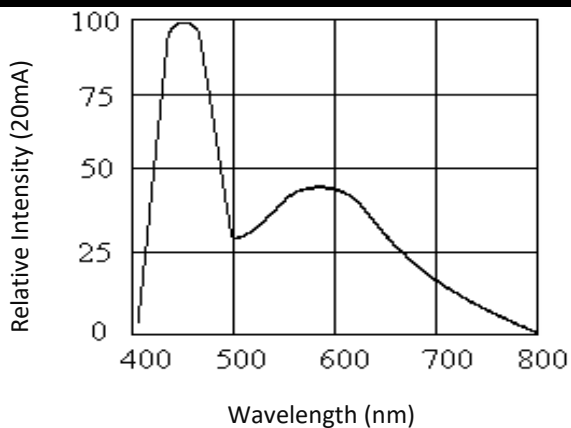
ELECTRO-OPTICAL CHARACTERISTICS:
Relative Intensity v.s. Forward Current

Forward Current v.s. Forward Voltage

Relative Intensity v.s. Temperature

Forward Current v.s. Temperature

Relative Intensity v.s. Wavelength

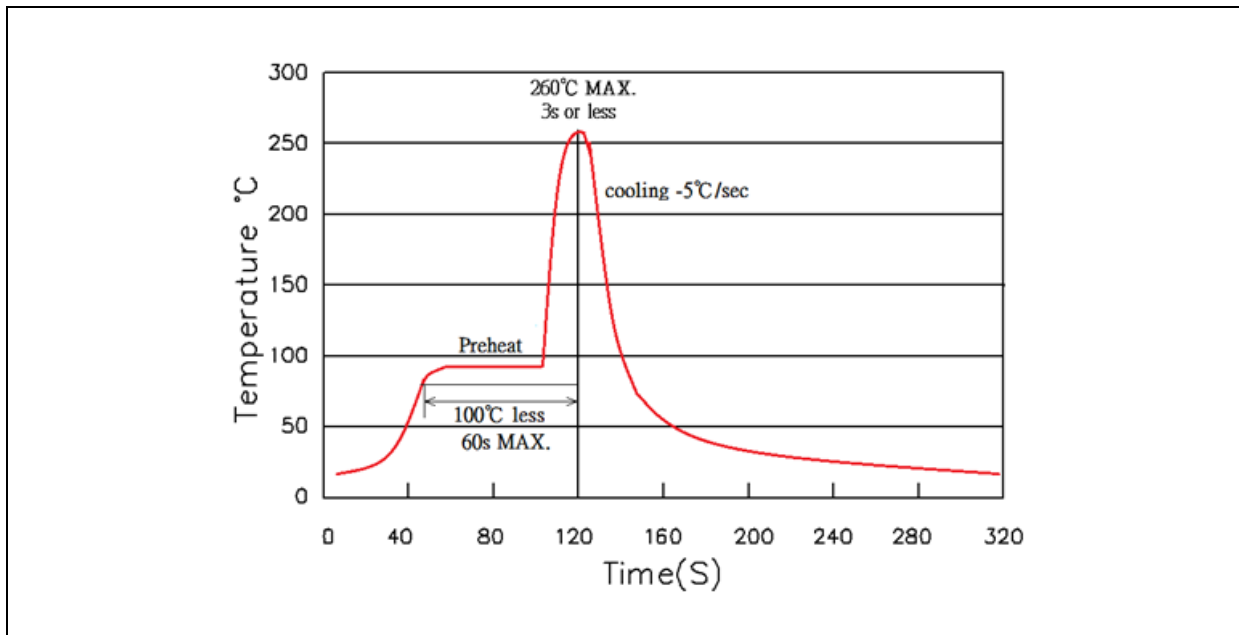
RECOMMENDED SOLDERING PROFILE:

Hand Solder (Solder Iron):

- Temperature at tip of iron: 350°C Max.
- Soldering Time: 3 seconds \pm 1 sec.

Soldering Heat (DIP):



Note:

1. Maximum reflow soldering: 1 time.
2. Before, during, and after soldering, should not apply stress on the components and PCB board.

PACKING SPECIFICATION:

Reel Dimension:

500pcs/Bulk

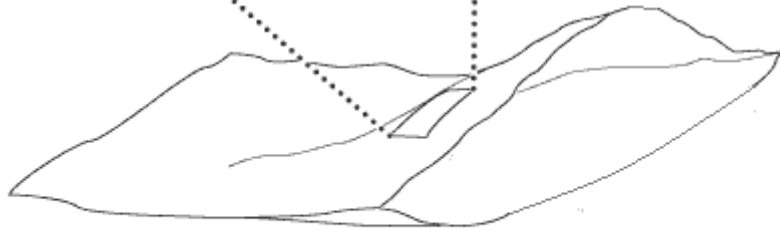

2000pcs/Taping

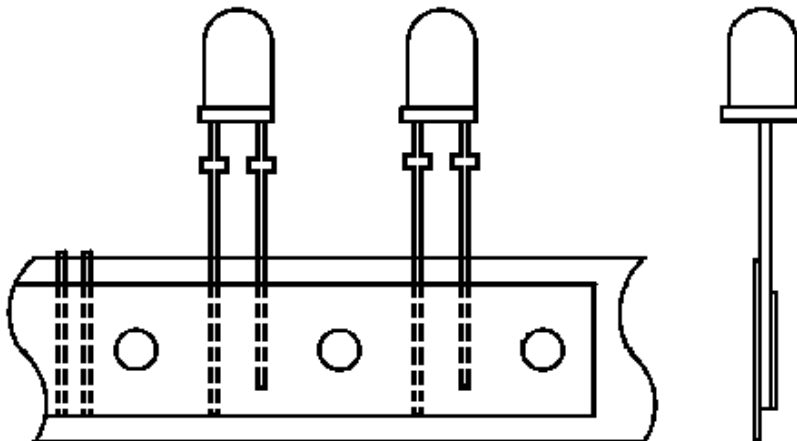

PRECAUTIONS OF USE:

Storage:

It is recommended to store the products in the following conditions:

- Humidity: 60% R.H. Max.
- Temperature: 5°C~30°C (41°F ~86°F).

Shelf life in sealed bag: 12 months at 5°C~30°C and <60% R.H.

Once the package is opened, the products should be used within a year. Otherwise, they should be kept in a damp-proof box with desiccating agent <10% R.H. and apply baking before use.

Baking:

It is recommended to bake the LED before soldering if the pack has been unsealed for longer than 24hrs. The suggested baking conditions are as followings:

- 60±5°C x 24hrs and <5%RH, taped / reel package.

It's normal to see slight color fading of carrier (light yellow) after baking in process.

Testing Circuit:

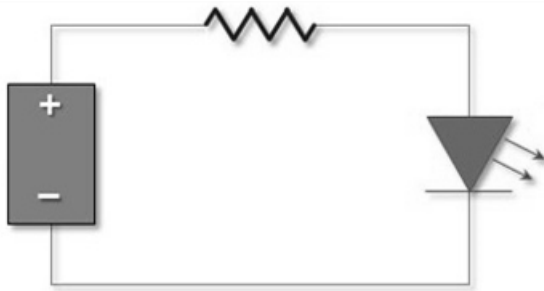

Must apply resistor(s) for protection (over current proof).

Cleaning:

Use alcohol-based cleaning solvents such as isopropyl alcohol to clean the LED carrier / package. Avoid putting any stress force directly on to the LED lens.

ESD (Electrostatic Discharge):

Static Electricity or power surge will damage the LED. Use of a conductive wrist band or anti-electrosatic glove is recommended when handling the LED all time. All devices, equipment, machinery, work tables, and storage racks must be properly grounded.

In the events of manual working in process, make sure the devices are well protected from ESD at any time.

REVISION RECORD:

Version	Date	Summary of Revision
A1.0	23/03/2023	Datasheet set-up.
A1.1	27/12/2023	Revise storage condition.