

6306-2Z

SKF Explorer

Dimensions

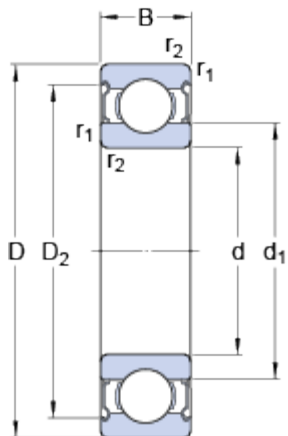

d	30	mm
D	72	mm
B	19	mm
d ₁	≈ 44.6	mm
D ₂	≈ 61.88	mm
r _{1,2}	min. 1.1	mm

Abutment dimensions

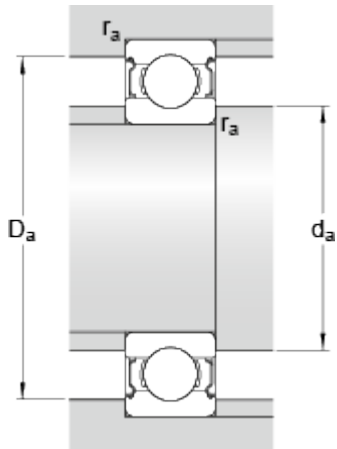

d _a	min. 37	mm
d _a	max. 44.5	mm
D _a	max. 65	mm
r _a	max. 1	mm

Calculation data

Basic dynamic load rating	C	29.6	kN
Basic static load rating	C ₀	16	kN
Fatigue load limit	P _u	0.67	kN
Reference speed		20000	r/min
Limiting speed		11000	r/min
Calculation factor	k _r	0.03	
Calculation factor	f ₀	13.1	

Mass

Mass bearing	0.36	kg
--------------	------	----